

SUPPLEMENTAL RESTRAINT SYSTEM

PRE-CHECK

DI60Y-14

NOTICE:

If the ignition switch is turned ON with the airbag sensor assembly connectors disconnected, or if a vehicle battery is removed with the ignition switch ON, the system will determine this condition as a failure and it will automatically call the call center. When an accidental call is made automatically, access to the call center and ask them to cut off the line.

To prevent this, perform the following when working on operation related to the airbag sensor assembly or battery:

- Disconnect the connectors of the mayday ECU and the back-up battery before disconnecting the airbag sensor assembly connector.
- Be sure that the ignition switch is OFF when removing a vehicle battery.
- If not signal has been received from the airbag sensor assembly since the ignition switch was turned ON, a service call will be made.
- If good signal reception from the airbag sensor assembly after the ignition switch ON is interrupted, an emergency call will be made.

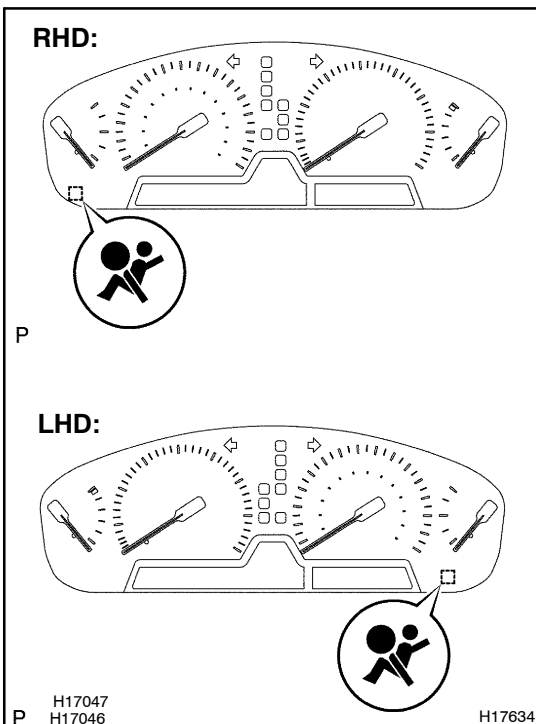

1. SRS WARNING LIGHT CHECK

- (a) Turn the ignition switch to the ON position and check that the SRS warning light lights up.
- (b) Check that the SRS warning light goes out after approx. 6 seconds.

HINT:

- When the ignition switch is at ON and the SRS warning light remains on or flashes, the airbag sensor assembly has detected a malfunction code.
- If, after approx. 6 seconds have elapsed, the SRS warning light lights up or the SRS warning light lights up even when the ignition switch is OFF, a short in the SRS warning light circuit can be considered likely. Proceed to "SRS warning light circuit malfunction" on [page DI-86](#).

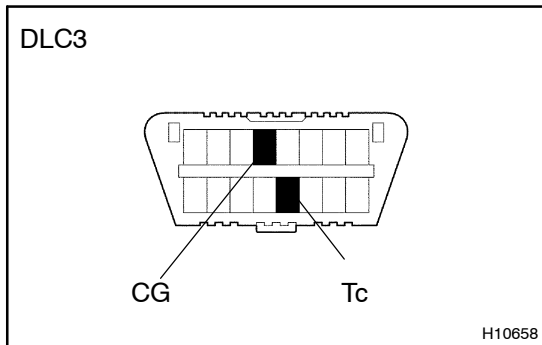

2. DTC CHECK (Using diagnosis check wire)

(a) Present troubles codes:

Output the DTC.

(1) Turn the ignition switch to the ON position and wait for approx. 20 seconds.

(2) Using SST, connect terminals Tc and CG of the DLC3.

SST 09843-18040

NOTICE:

Pay due attention to the terminal connecting position to avoid a malfunction.

(b) Past troubles codes:

Output the DTC.

(1) Using service wire, connect terminals Tc and CG of the DLC3.

SST 09843-18040

(2) Turn the ignition switch to the ON position and wait for approx. 20 seconds.

NOTICE:

Pay due attention to the terminal connecting position to avoid a malfunction.

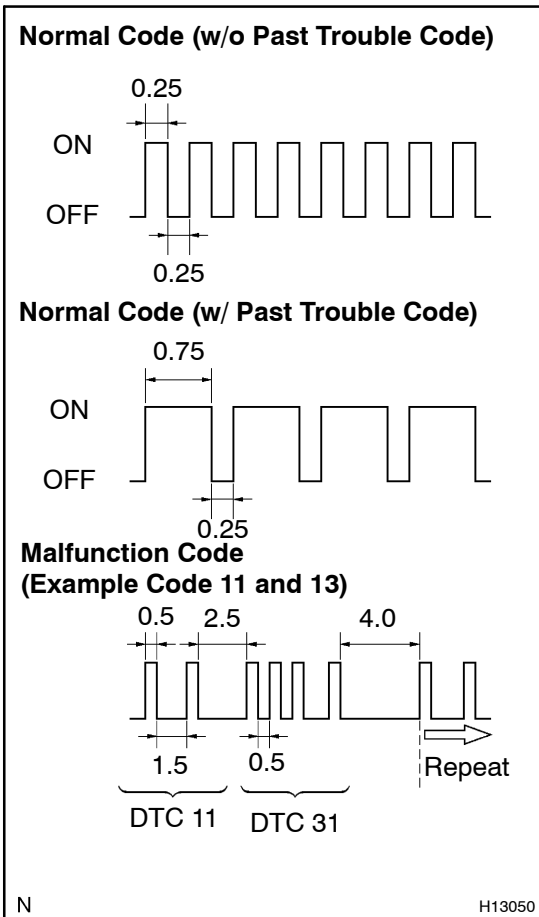

- (c) Read the DTC.
- Read the 2-digit DTC as indicated by the number of times the SRS warning light blinks. As an example, the blinking patterns, normal, 11 and 31 are shown in the illustration.
- Normal code indication (w/o past trouble code)
The light will blink 2 times per second.
 - Normal code indication (w/ past trouble code)
When the past troubles code is stored in the airbag sensor assembly, the light blinks only ones a second.
 - Malfunction code indication
The first blinking output indicates the first digit of a 2-digit DTC. After a 1.5-second pause, the second blinking output will indicate the second digit.

If there are 2 or more codes, there will be a 2.5-second pause between each code. After all the codes have been output, there will be a 4.0-second pause and they will all be repeated.

HINT:

- In the event of a number of trouble codes, indication will start from the smallest numbered code.
- If a DTC is not output or a DTC is output without terminal connection, proceed to the Tc terminal circuit inspection on page DI-710 of Pub. No. RM792E.

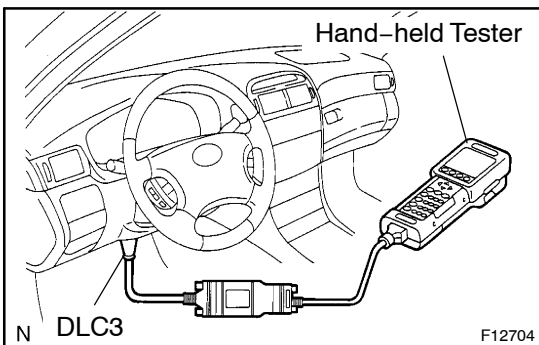

3. DTC CHECK (Using hand-held tester)

- Hook up the hand-held tester to the DLC3.
- Read the DTCs by following the prompts on the tester screen.

HINT:

Please refer to the hand-held tester operator's manual for further details.

4. DTC CLEARANCE (Not using service wire)

When the ignition switch is turned off, the diagnostic trouble code is cleared.

HINT:

DTC might not be cleared by turning the ignition switch OFF. In this case, proceed to the next step.

5. DTC CLEARANCE (Using service wire)

- Connect the service wire to terminals Tc of the DLC3.
- Ground terminal Tc of the DLC3.
- Turn the ignition switch to the ON position.
- Within 3 to 10 sec. after DTC is started to be output, release ground from terminal Tc of the DLC3.

- (e) The SRS warning light lights up 2 to 4 sec. later. Within 1 to 5 sec. after that, ground terminal Tc of the DLC3.
- (f) The SRS warning light goes off 2 to 4 sec. after grounding terminal Tc. Within 1 to 5 sec. after that, release ground from terminal Tc again.
- (g) The SRS warning light lights up again 2 to 4 sec. later. Within 1 to 5 sec. after that, ground terminal Tc of the DLC3 again.
- (h) The SRS warning light goes off 2 to 4 sec. later. Within 1 sec. after that, normal code is output indicating that DTC deletion is completed.

If DTCs are not cleared, repeat the above procedure until the codes are cleared.

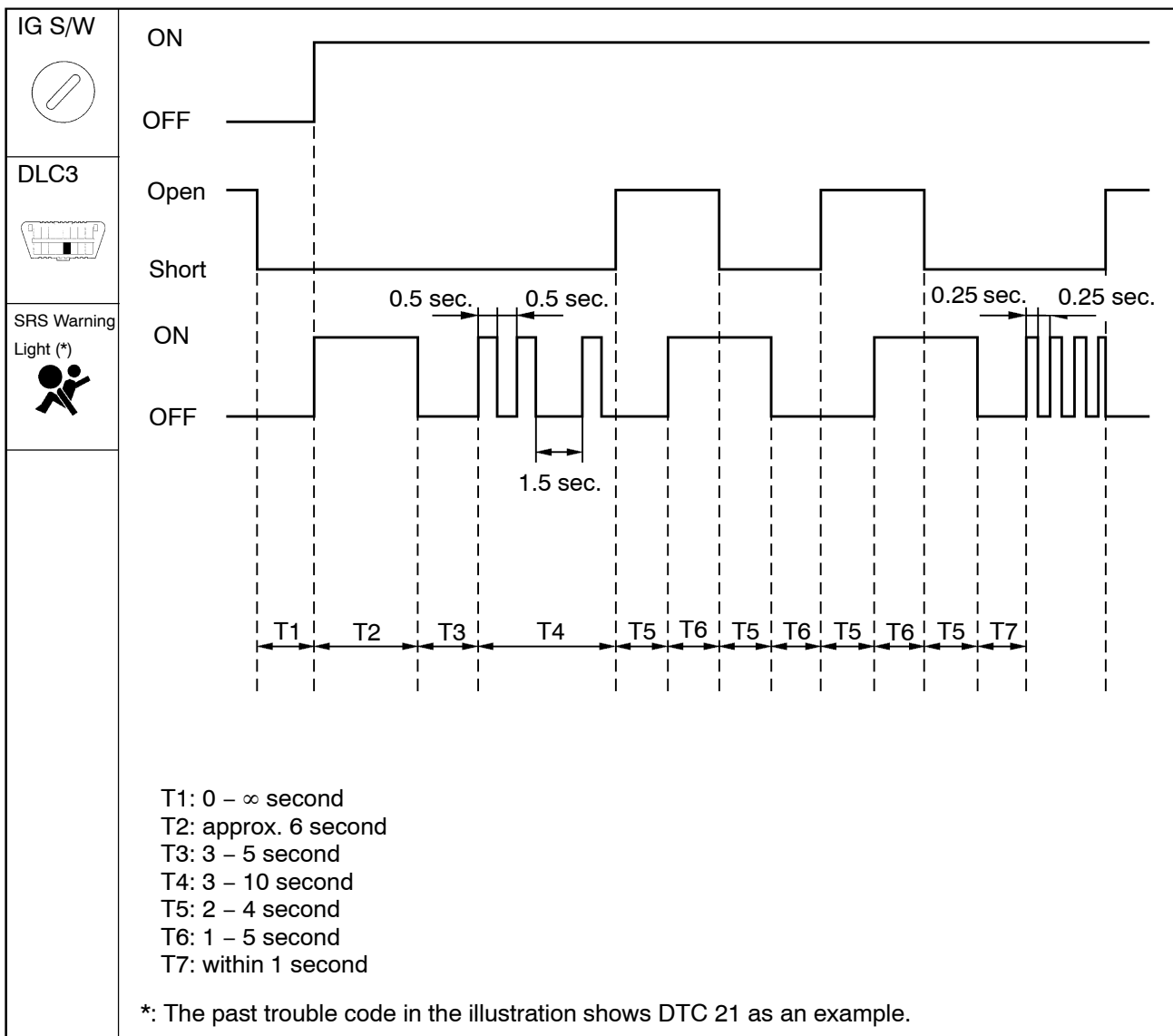

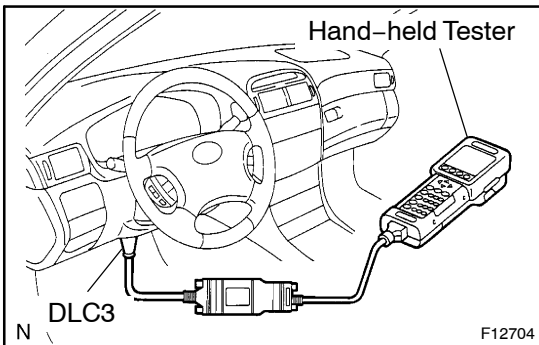

6. DTC CLEARANCE (Using hand-held tester)

- (a) Hook up the hand-held tester to the DLC3.
- (b) Clear the DTCs by following the prompts on the tester screen.

HINT:

Please refer to the hand-held tester operation's manual for further details.

7. RELEASE METHOD OF AIRBAG ACTIVATION PREVENTION MECHANISM

An airbag activation prevention mechanism is built into the connector for the squib circuit of the SRS.

When release of the airbag activation prevention mechanism is directed in the troubleshooting procedure, as shown in the illustration of the connectors on the next pages, insert paper which has the same thickness as the male terminal between the terminal and the short spring.

CAUTION:

Never release the airbag activation prevention mechanism on the squib connector.

NOTICE:

- Do not release the airbag activation prevention mechanism unless specifically directed by the troubleshooting procedure.
- If the inserted paper is too thick the terminal and short spring may be damaged, so always use paper with the same thickness as the male terminal.

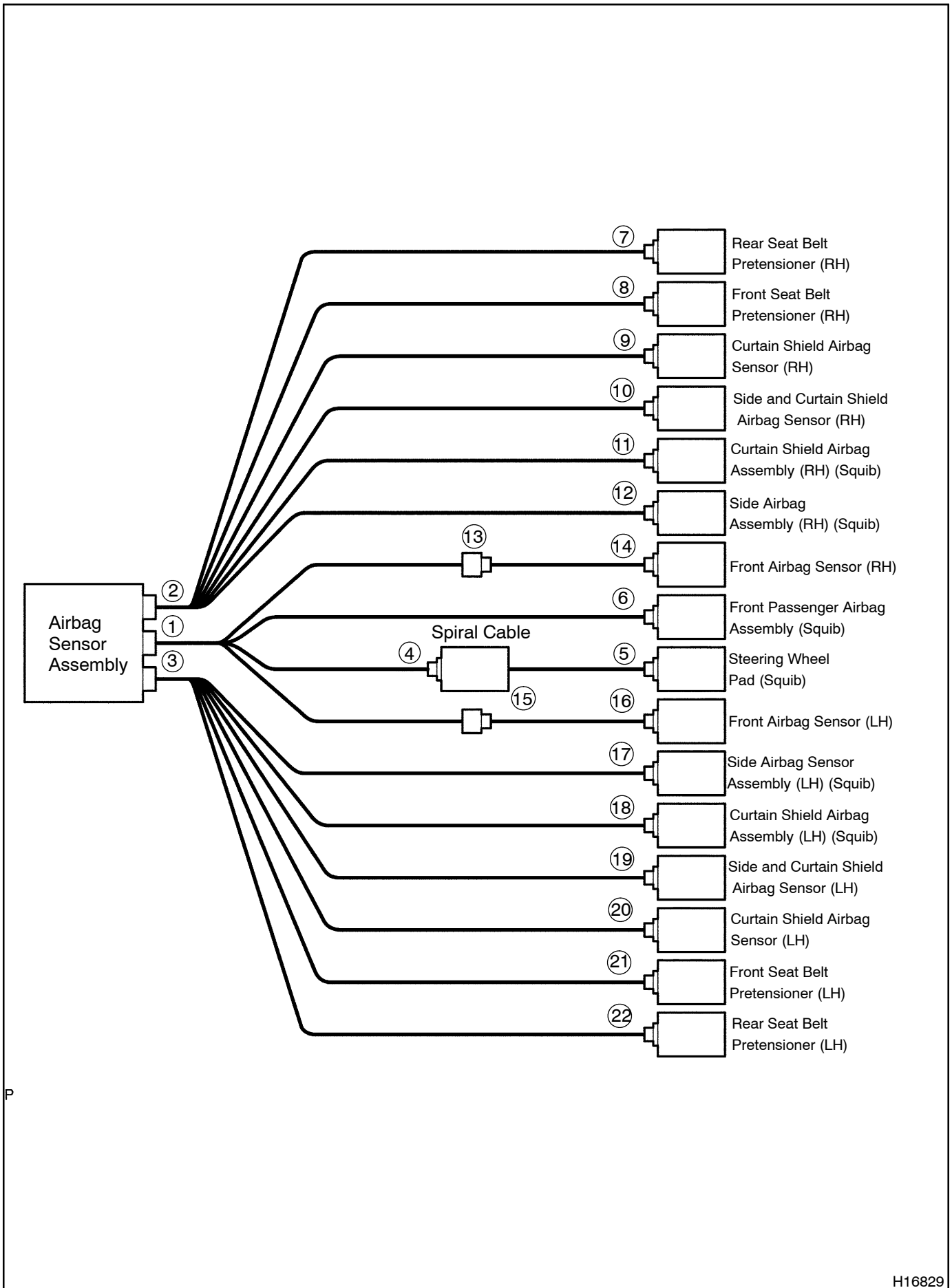

P

Airbag Sensor Assembly Connector

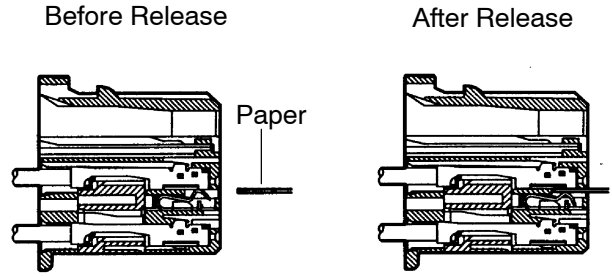
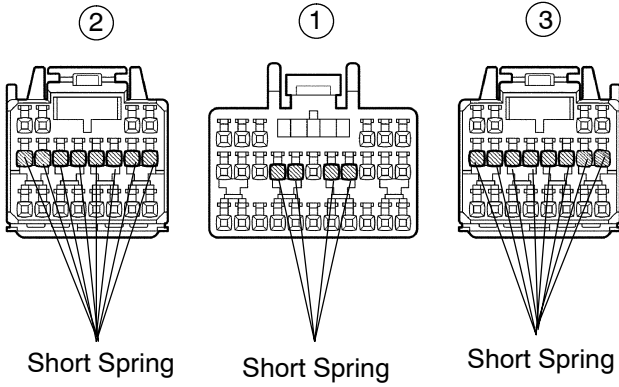

Connector ⑪ ⑱

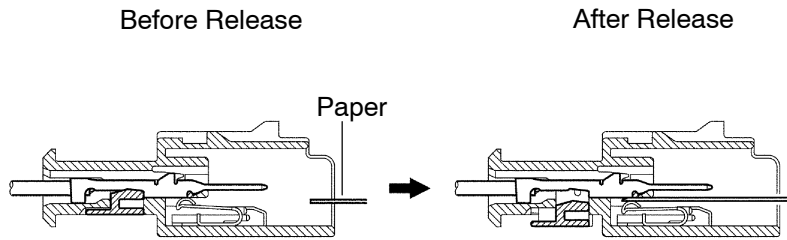
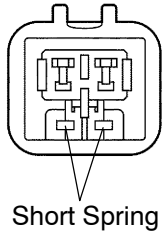

Connector ④ ⑥

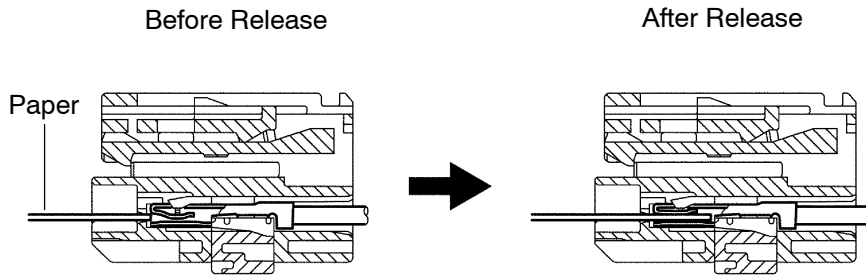
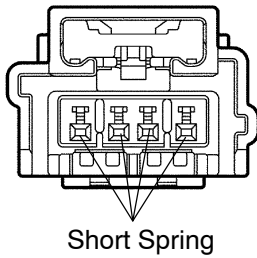

Connector ⑫ ⑰

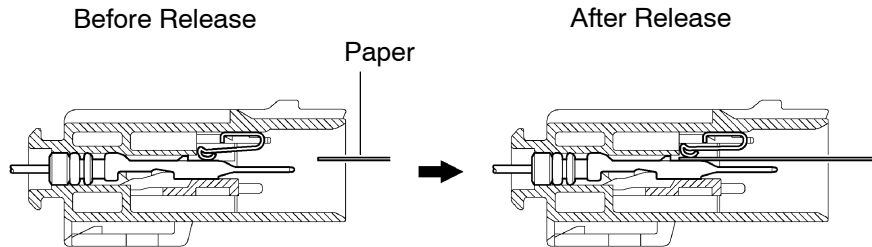
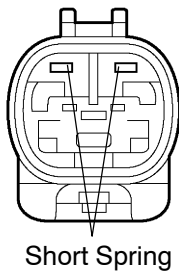

H16882 H01233
 H02248 H02249
 H16883
 H09672 H09658

H17031