

PRE-CHECK

1. WARNING FOR A/C COMPRESSOR LOCK

If compressor lock occurs during A/C operation, the A/C switch indicator on the A/C control assembly starts blinking. When this occurs, check for compressor lock (DTC 1422/22) using diagnosis trouble code check then proceed to inspect the circuit or the component.
Compressor lock sensor circuit. → (See page DI-1796)

2. LIST OF OPERATION METHODS

By operating each of the A/C control switches as shown in the diagram below, it is possible to enter the diagnosis check mode.

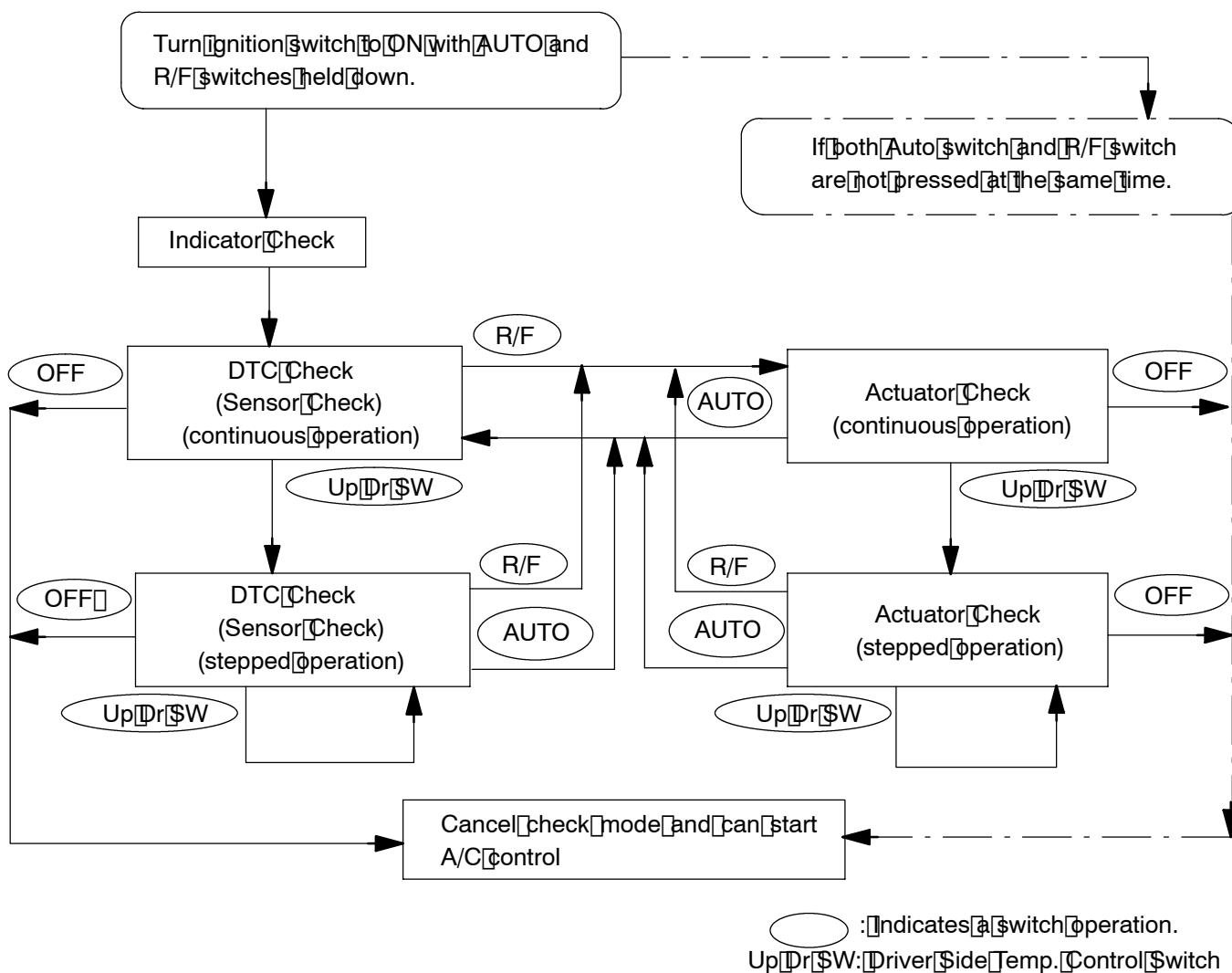

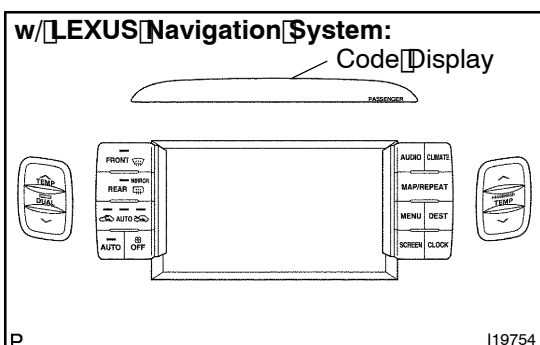
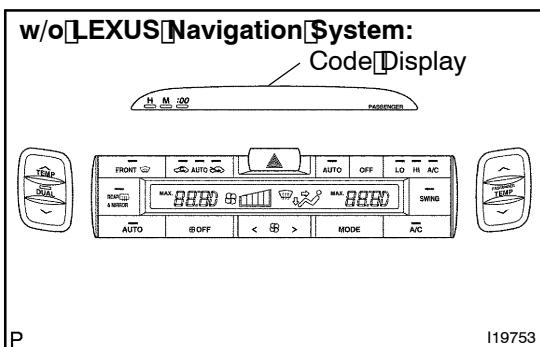
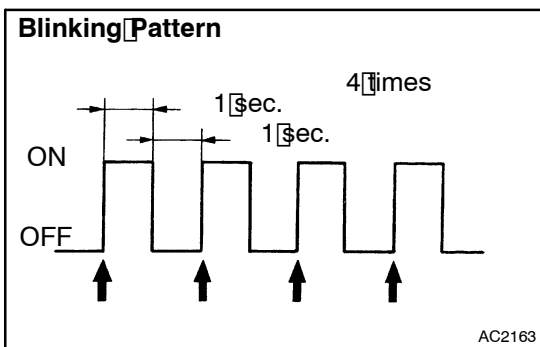
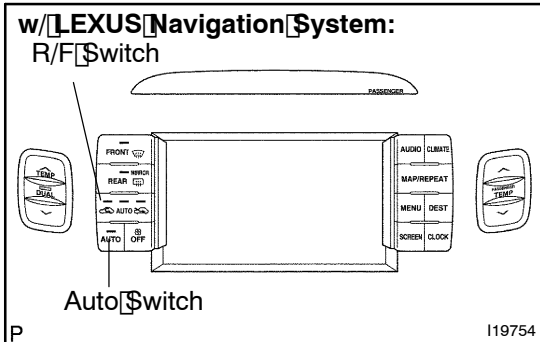
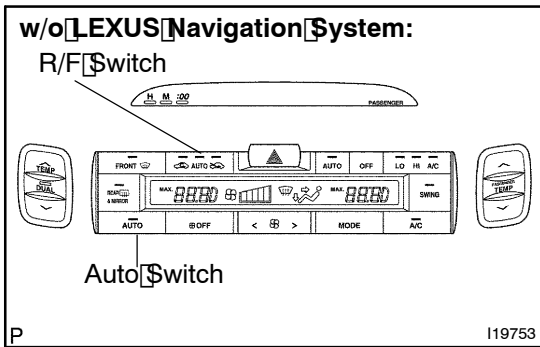

3. INDICATOR CHECK

- (a) Turn the ignition switch to ON while pressing the A/C control AUTO switch and R/F switch simultaneously.

- (b) Check that all indicators light up and go off at 1 second intervals 4 times in succession.

- (c) Check that the buzzer sounds when the indicators light up in 2.

HINT:

- After the indicator check is ended, the diagnostic trouble code check begins automatically.
- Press the OFF switch when cancelling the check mode.

4. DTC CHECK (SENSOR CHECK)

- (a) Perform an indicator check. After the indicator check is completed, the system enters the DTC check mode automatically.

- (b) Read the code displayed on the panel. Refer to the list of codes on [page DI-1763](#) when reading the trouble codes. (Trouble codes are output at the driver side temperature display.)

If the slower display is desired, press the driver side UP switch and change it to step operation. Each time the UP switch is pressed, the display changes by 1 step.

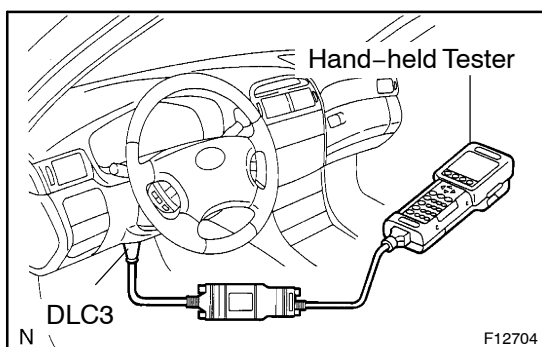
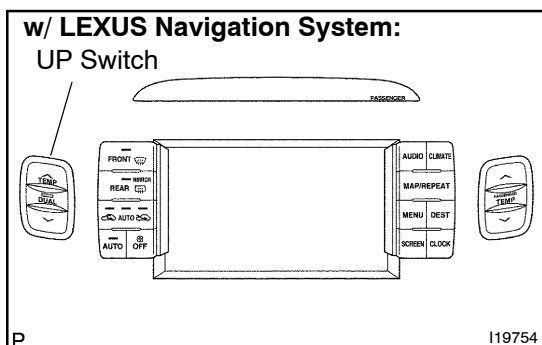
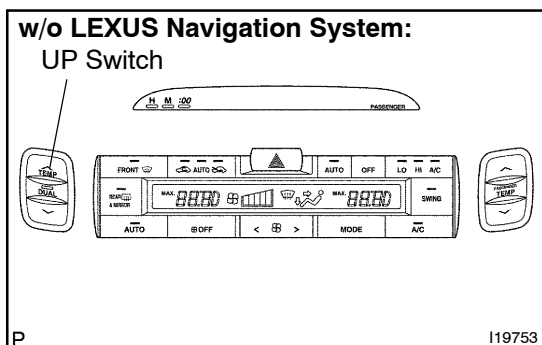
**HINT:**

- If the buzzer sounds when a trouble code is being read, it means the trouble indicated by that trouble code continues to occur.
- If the buzzer does not sound when a trouble code is being read, it means the trouble indicated by that trouble code occurred earlier (such as poor connector contacts, etc.).

5. DTC CHECK USING HAND-HELD TESTER

- Hook up the hand-held tester to the DLC3.
- Read the DTC the following the prompts on the tester screen. Please refer to the hand-held tester operator's manual for further details.

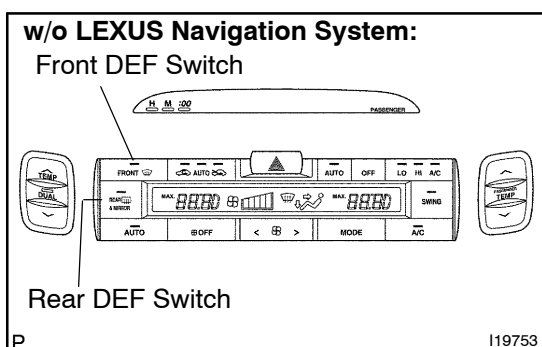
**6. CLEARING DTC**

Clear DTC memory by one of the following operations:

- During sensor check, press the "Rr DEF" switch while pressing the "Front DEF" switch.

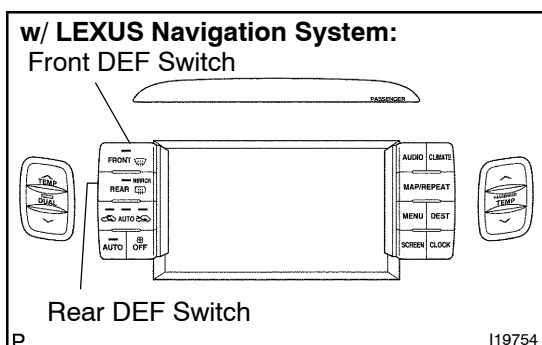

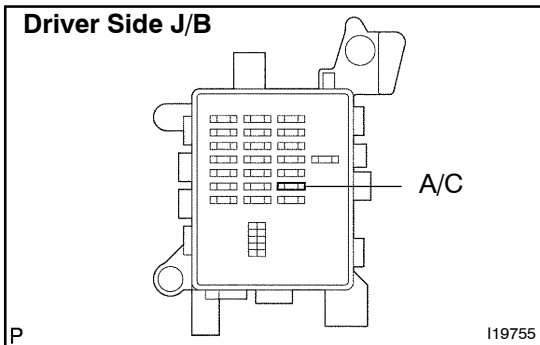

- (2) Pull out the A/C fuse in the driver side J/B for 30 seconds or longer to clear the DTC memory.
- (3) After reinserting the fuse, check that the normal code is output.

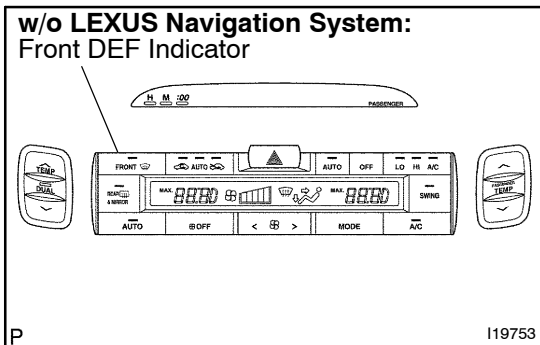

7. STEP MOTORS INITIALIZING FUNCTION

Step motor initializing procedure (Automatic initializing).

- (1) The battery is connected and ignition switch is turned to ON for the first time, the initializing function of the step motors is activated. In this case, the "FRONT DEF" indicator blinks.

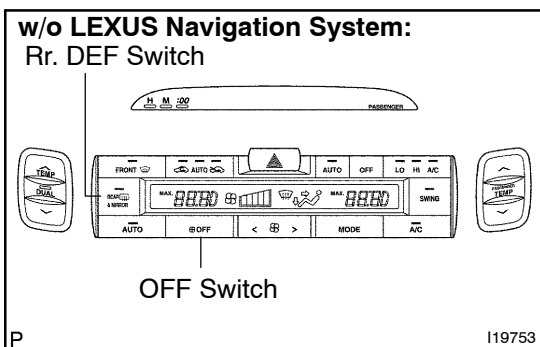
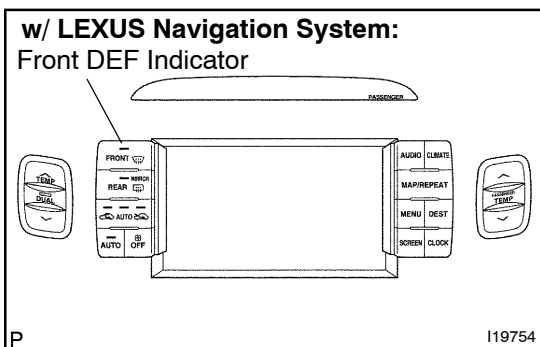

- (2) If mode indication is different from the actual air outlet in actuator check, turn ignition switch to ON or START while pressing "Rr DEF" and "OFF" switches simultaneously. Step motor initialization occurs and the "DEF" indicator blinks.

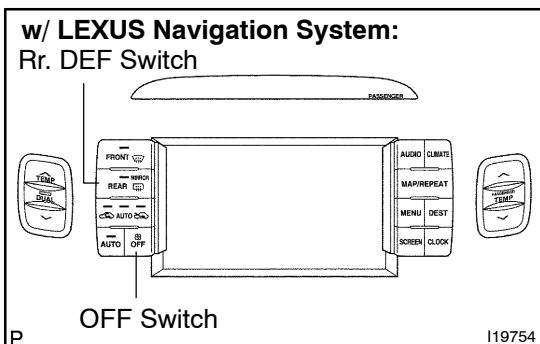

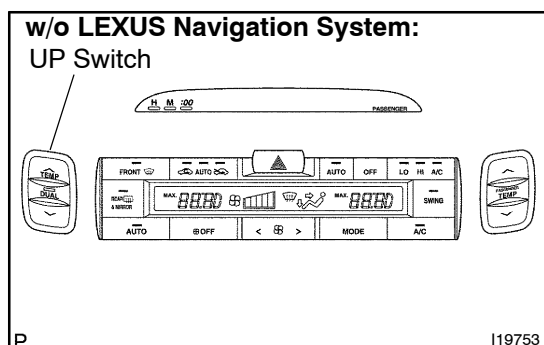
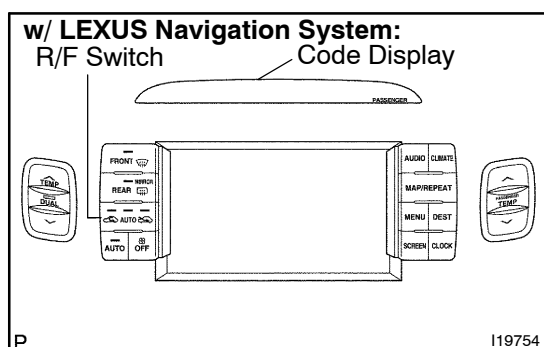
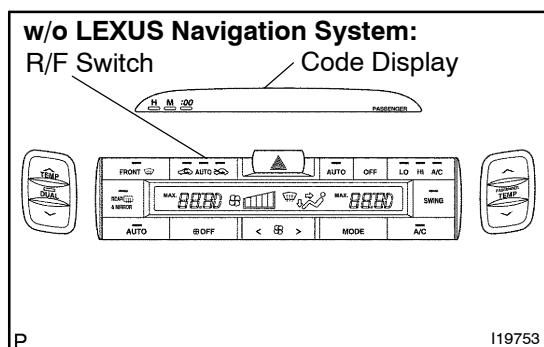
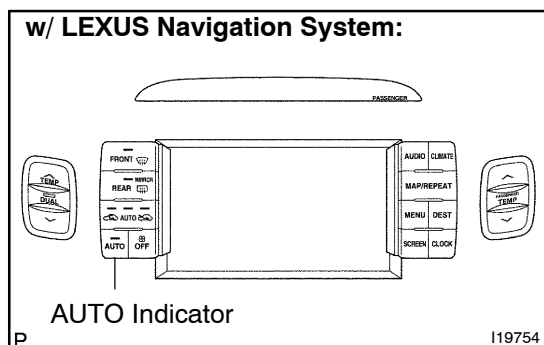
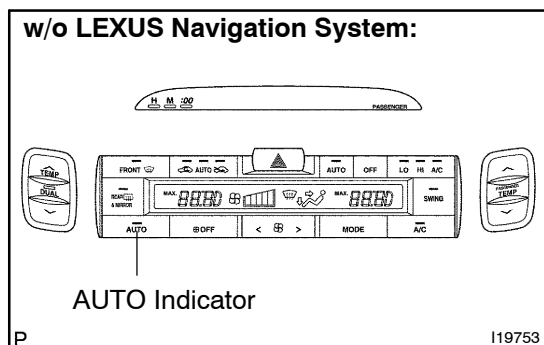

8. RESTRICTION OF STEP MOTORS CONTINUES OPERATION

If the step motor is continuously operating for many hours, the step motor is forced to stop and the "AUTO" indicator blinks. In this case, the step motor automatically restores after cooling for approx. 7 minutes.

9. ACTUATOR CHECK

- After entering the sensor check mode, press the R/F switch.
- Since each damper, motor and relay automatically operates at 1 sec. intervals beginning in order from 0 in the temperature display, check the temperature and air flow visually and by hand.

If the slower display is desired, press the driver UP switch and change it to step operation. Each time the driver UP switch is pressed, the display changes by 1 step.

HINT:

- The buzzer sounds when the display trouble code changes.
- Code are displayed in order from the smaller to the larger numbers.
- To cancel the check mode, press the OFF switch.

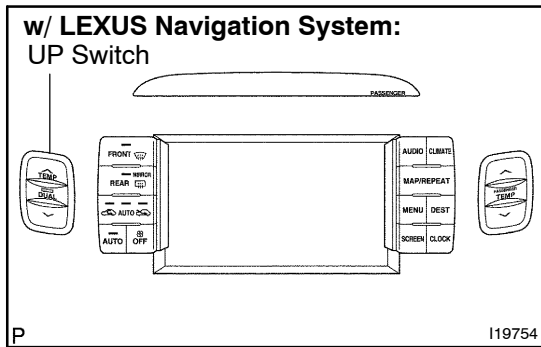

Step No.	Display Code	Conditions								
		Blower motor	Air flow vent	Max. cool damper	Air inlet damper	Magnetic clutch	Air mix damper	Water valve	Rear A/C	Deicer
1	0	OFF	FACE	0% open	FRESH	OFF	Cool side (0% open)	SHUT	OFF	OFF
2	1	1	↑	↑	↑	↑	↑	↑	LO A/P	ON
3	2	17	↑	↑	F/R FRESH*	ON	↑	↑	HIA/P	OFF
4	3	↑	↑	100% open	RECIRC	↑	↑	OPEN	HIA/C	ON
5	4	↑	BI-LEVEL	↑	FRESH	↑	Cool / Hot (50% open)	↑	↑	OFF
6	5	↑	↑	↑	↑	↑	↑	↑	LO A/C	ON
7	6	↑	FOOT	↑	↑	↑	↑	↑	OFF	OFF
8	7	↑	↑	↑	↑	↑	Hot side (100% open)	↑	↑	ON
9	8	↑	FOOT/DEF	↑	↑	↑	↑	↑	↑	OFF
10	9	31	DEF	↑	↑	↑	↑	↑	↑	ON

*: G. C. C. Countries

A/P: Air purifier