

<b>DTC</b>	<b>P0500/42</b>	<b>Vehicle Speed Sensor Malfunction</b>
------------	-----------------	---

**CIRCUIT DESCRIPTION**

The vehicle speed sensor detects the rotation speed of the transmission output shaft and sends signals to the engine ECU. The engine ECU determines the vehicle speed based on these signals. An AC voltage is generated in the vehicle speed sensor coil as the rotor mounted on the output shaft rotates, and this voltage is sent to the engine ECU.

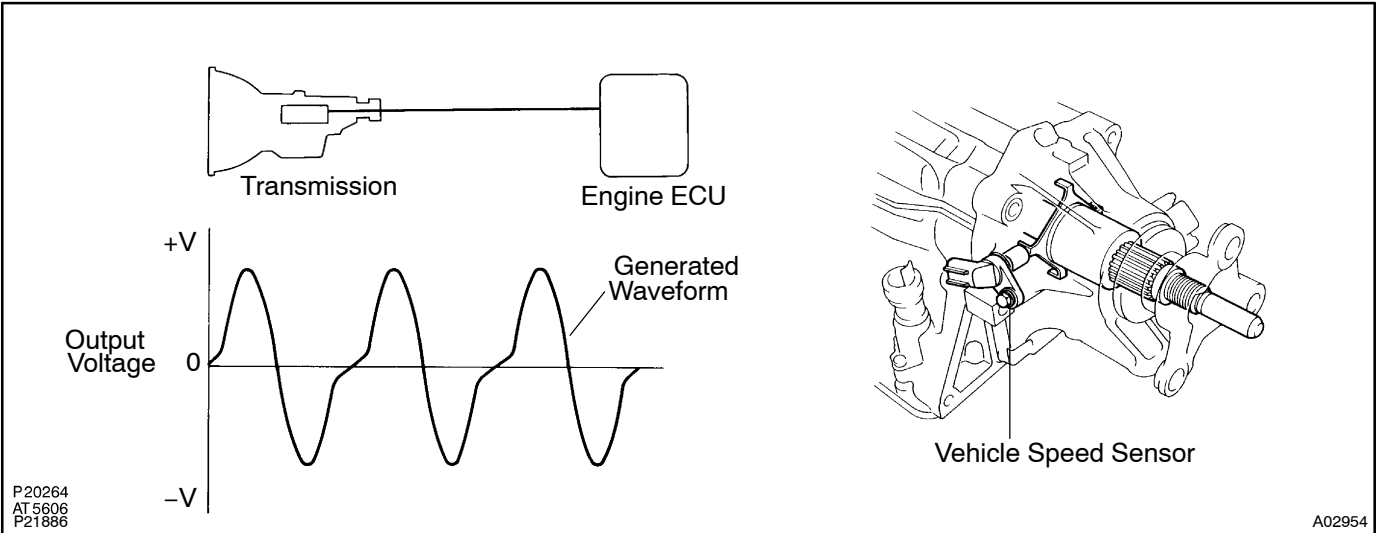

DTC No.	DTC Detecting Condition	Trouble Area
P0500/42	No vehicle speed sensor signal to engine ECU under conditions (a) and (b): (a) park/neutral position switch is OFF (b) Vehicle is being driven	<ul style="list-style-type: none"> <li>• Open or short in vehicle speed sensor circuit</li> <li>• Vehicle speed sensor</li> <li>• Engine ECU</li> </ul>

**WIRING DIAGRAM**

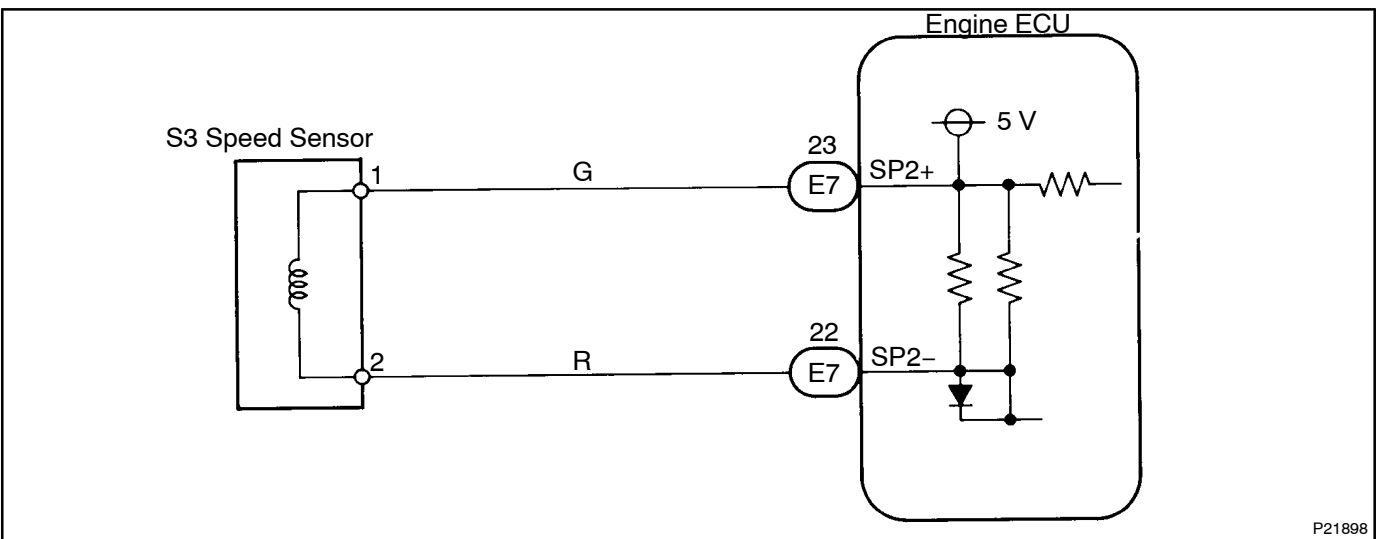

## INSPECTION PROCEDURE

### When using hand-held tester:

#### HINT:

Read freeze frame data using hand-held tester. Because freeze frame records the engine conditions when the malfunction is detected, when troubleshooting it is useful for determining whether the vehicle was running or stopped, the engine warmed up or not, the air-fuel ratio lean or rich, etc. at the time of the malfunction.

1 Connect hand-held tester and read value of vehicle speed value.

#### PREPARATION:

- (a) Connect the hand-held tester to the DLC3.
- (b) Start the engine and the hand-held tester main switch ON.

#### CHECK:

Drive the vehicle and read vehicle speed value.

#### OK:

Vehicle speed matches tester speed value

OK

Check and replace engine ECU (See page IN-35).

NG

2 Check speedometer circuit (See page BE-67).

NG

Repair or replace speedometer circuit.

OK

### 3 Check resistance between terminals SP2+ and SP2- of engine ECU connector.

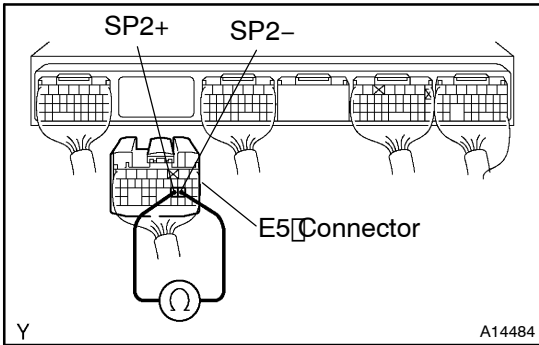

#### PREPARATION:

- Remove the engine room ECU cover.
- Disconnect the E5 connector of the engine ECU.

#### CHECK:

Check resistance between terminals SP2+ and SP2- of the engine ECU connector.

#### OK:

Resistance: 560 – 680 Ω

OK

Check and replace engine ECU (See page IN-35).

NG

### 4 Check vehicle speed sensor.

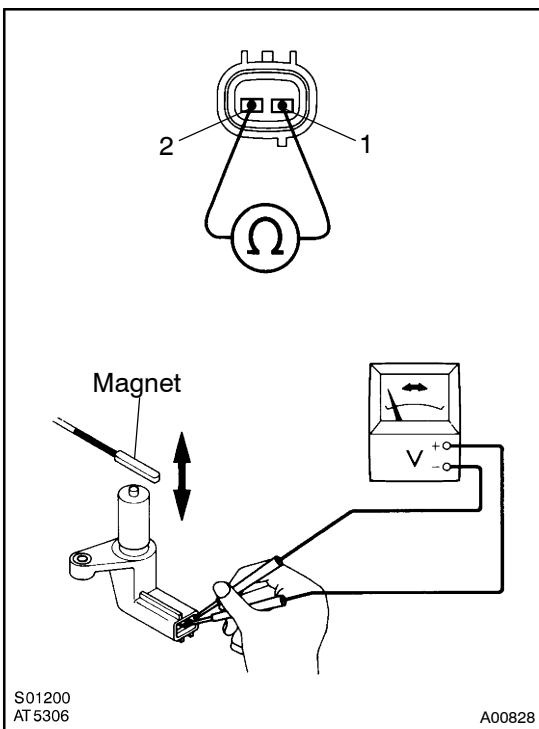

#### PREPARATION:

Remove the vehicle speed sensor from the transmission.

#### CHECK:

Measure resistance between terminals 1 and 2 of the speed sensor.

#### OK:

Resistance: 560 – 680 Ω

#### Reference: Check vehicle speed sensor's function

#### CHECK:

Check voltage between terminals 1 and 2 of the vehicle speed sensor when a magnet is put close to front end of the vehicle speed sensor then taken away quickly.

#### OK:

Voltage is generated intermittently

#### HINT:

Voltage generated is extremely low.

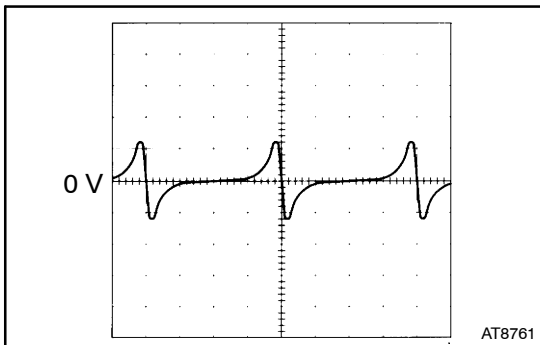
**Reference: INSPECTION USING OSCILLOSCOPE**

Waveform between terminals SP2+ and SP2- When the vehicle speed is approx. 60 km/h (37 mph).

**NG****Replace vehicle speed sensor.****OK**

**Check and repair harness and connector between engine ECU and vehicle speed sensor (See page IN-35).**

**When not using hand-held tester:**

- 1 Check resistance between terminals SP2+ and SP2- of engine ECU connector.

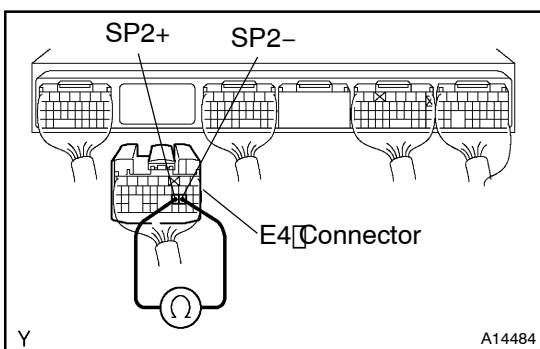
**PREPARATION:**

- (a) Remove the engine room ECU cover.  
 (b) Disconnect the E4 connector of the engine ECU.

**CHECK:**

Check resistance between terminals SP2+ and SP2- of the engine ECU connector.

**OK:**

**Resistance: 560 - 680 Ω**

**OK****Check and replace engine ECU (See page IN-35).****NG**

## 2 Check vehicle speed sensor.

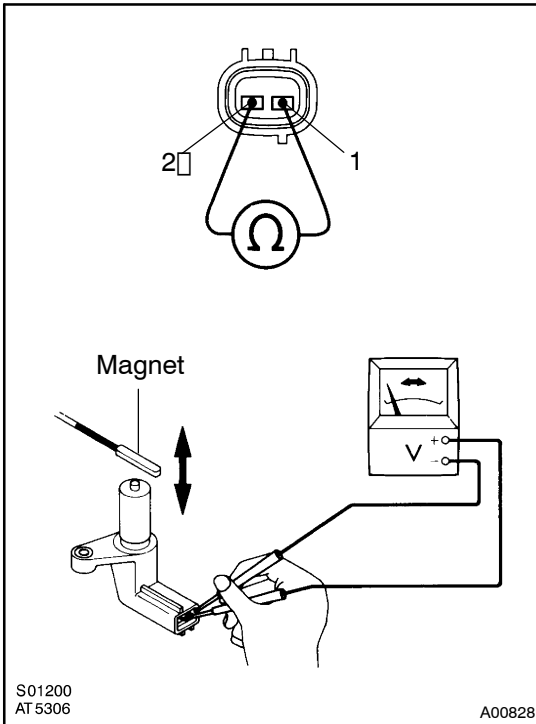

### PREPARATION:

Remove the vehicle speed sensor from the transmission.

### CHECK:

Measure resistance between terminals 1 and 2 of the speed sensor.

### OK:

**Resistance:** 560 – 680  $\Omega$

**Reference:** Check vehicle speed sensor's function

### CHECK:

Check voltage between terminals 1 and 2 of the vehicle speed sensor when a magnet is put close to front end of the vehicle speed sensor then taken away quickly.

### OK:

**Voltage is generated intermittently**

### HINT:

Voltage generated is extremely low.

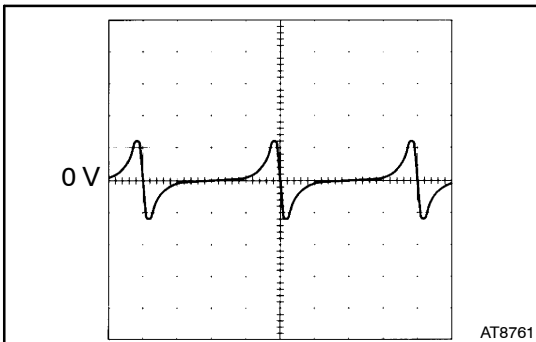

### Reference: INSPECTION USING OSCILLOSCOPE

Waveform between terminals SP2+ and SP2- When the vehicle speed is approx. 60 km/h (37 mph).

NG

replace vehicle speed sensor.

OK

Check and repair harness and connector between engine ECU and vehicle speed sensor (See page N-35).